

# PART EJECTION

## Blades

Ejector Blades.....B20

## Knockouts

Hex Series Knockout Rod Extensions.....B29

Round Series Knockout Rod Extensions.....B30

## Pins

Armor Coated Ejector Pins.....B14

Armor Coated Ejector Pins - Oversized.....B16

Armor Coated Step Pins.....B18

Armor Coated Step Pins - Oversized.....B19

Hardened Throughtout® Ejectors Pins.....B3

Hardened Throughtout® Ejector Pins - D-Head.....B6

Hardened Throughtout® Ejectors Pins - Oversized.....B4

Hardened Throughtout® Step Pins.....B7

Hardened Throughtout® Step Pins - D-Head.....B8

Hardened Throughtout® Step Pins - Oversized.....B9

Nitrided Ejector Pins.....B11

Nitrided Ejector Pins - D-Head.....B13

Nitrided Ejector Pins - Oversized.....B12

# PART EJECTION

## Sleeves

Ejector Sleeve Extensions.....	B25
Nitrided Ejector Sleeves.....	B22
Nitrided Ejector Sleeves - D-Head.....	B23
Oversized Ejector Sleeves.....	B23
Thin Wall Ejector Sleeves.....	B24

# Hardened Throughtout® Ejector Pins

- Can be used as an ejector or core pin
- Pins 6" and longer have annealed heads to minimize brittleness and allow for easier machining
- All pin sizes with diameter greater than 3/32" are etched for identification



SPECIFICATIONS	
R Pin to Head Radius	R.030
Core Hardness	48 - 55 Rc
Surface Hardness	65 - 74 Rc
Material Type	Premium Hot Work Steel
Unit of Measure	Inch

D PIN DIAMETER TOLERANCES	
P3 - P33	+ .0000 / - .0003
P34 - P47	+ .0000 / - .0005

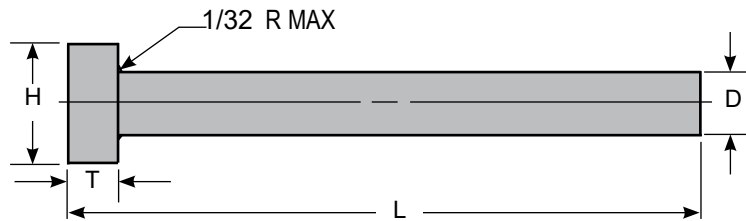

D PIN DIA.	ACTUAL SIZE	H HEAD DIA. +.000 -.010	T HEAD THICK. +.000 -.002	L OVERALL LENGTH +.062 / -.000											
				4"		6"		8"		10"		12"		14"	
				STD	STD	.005 OS	STD	STD	.005 OS	STD	STD	.005 OS	STD	STD	.005 OS
1/32	.0307	1/8	1/8	P3-4	P3-6	P3-6 OS									
3/64	.0464	5/32	1/8	P4-4	P4-6	P4-6 OS									
1/16	.0620	3/16	1/8	P5-4	P5-6	P5-6 OS	P5-8	P5-10	P5-10 OS						
5/64	.0776	13/64	1/8	P6-4	P6-6	P6-6 OS	P6-8	P6-10	P6-10 OS						
3/32	.0933	7/32	1/8	P7-4	P7-6	P7-6 OS	P7-8	P7-10	P7-10 OS						
7/64	.1089	15/64	1/8	P8-4	P8-6	P8-6 OS	P8-8	P8-10	P8-10 OS						
1/8	.1245	1/4	1/8	P9-4	P9-6	P9-6 OS	P9-8	P9-10	P9-10 OS	P9-12	P9-14	P9-14 OS			
9/64	.1401	1/4	1/8	P10-4	P10-6	P10-6 OS		P10-10	P10-10 OS		P10-14	P10-14 OS			
5/32	.1557	9/32	5/32	P11-4	P11-6	P11-6 OS	P11-8	P11-10	P11-10 OS	P11-12	P11-14	P11-14 OS			
11/64	.1714	11/32	3/16	P12-4	P12-6	P12-6 OS		P12-10	P12-10 OS		P12-14	P12-14 OS			
3/16	.1870	3/8	3/16	P13-4	P13-6	P13-6 OS	P13-8	P13-10	P13-10 OS	P13-12	P13-14	P13-14 OS			
13/64	.2026	3/8	3/16	P14-4	P14-6	P14-6 OS		P14-10	P14-10 OS		P14-14	P14-14 OS			
7/32	.2183	13/32	3/16	P15-4	P15-6	P15-6 OS	P15-8	P15-10	P15-10 OS		P15-14	P15-14 OS			
15/64	.2339	13/32	3/16	P16-4	P16-6			P16-10	P16-10 OS		P16-14	P16-14 OS			
1/4	.2495	7/16	3/16	P17-4	P17-6	P17-6 OS	P17-8	P17-10	P17-10 OS	P17-12	P17-14	P17-14 OS			
17/64	.2651	7/16	1/4	P18-4	P18-6			P18-10	P18-10 OS		P18-14	P18-14 OS			
9/32	.2807	7/16	1/4	P19-4	P19-6		P19-8	P19-10	P19-10 OS		P19-14	P19-14 OS			
19/64	.2964	1/2	1/4	P20-4	P20-6			P20-10	P20-10 OS		P20-14	P20-14 OS			
5/16	.3120	1/2	1/4	P21-4	P21-6	P21-6 OS	P21-8	P21-10	P21-10 OS		P21-14	P21-14 OS			
21/64	.3276	9/16	1/4	P22-4	P22-6			P22-10	P22-10 OS		P22-14	P22-14 OS			

Continued on next page

## Hardened Throughtout® Ejector Pins

- Can be used as an ejector or core pin
- Pins 6" and longer have annealed heads to minimize brittleness and allow for easier machining
- All pin sizes with diameter greater than 3/32" are etched for identification



### SPECIFICATIONS

R Pin to Head Radius	R.030
Core Hardness	48 - 55 Rc
Surface Hardness	65 - 74 Rc
Material Type	Premium Hot Work Steel
Unit of Measure	Inch

### D PIN DIAMETER TOLERANCES

P3 - P33	+ .0000 / - .0003
P34 - P47	+ .0000 / - .0005

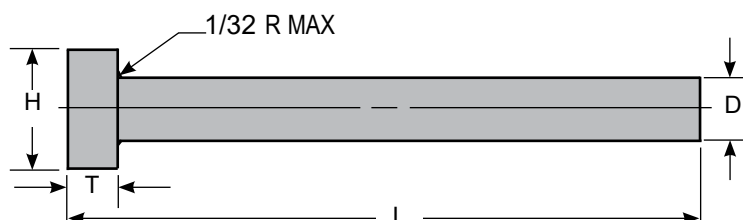

### L OVERALL LENGTH

D PIN DIA.	ACTUAL SIZE	H HEAD DIA. +.000 -.010	T HEAD THICK. +.000 -.002	L OVERALL LENGTH +.062 / -.000								
				4"	6"		8"	10"		12"	14"	
				STD	STD	.005 OS	STD	STD	.005 OS	STD	STD	.005 OS
11/32	.3433	9/16	1/4	P23-4	P23-6			P23-10	P23-10 OS		P23-14	P23-14 OS
23/64	.3589	5/8	1/4	P24-4	P24-6			P24-10	P24-10 OS		P24-14	P24-14 OS
3/8	.3745	5/8	1/4	P25-4	P25-6	P25-6 OS	P25-8	P25-10	P25-10 OS	P25-12	P25-14	P25-14 OS
25/64	.3901	37/64	1/4	P26-4	P26-6			P26-10	P26-10 OS		P26-14	P26-14 OS
13/32	.4057	11/16	1/4	P27-4	P27-6			P27-10	P27-10 OS		P27-14	P27-14 OS
27/64	.4214	11/16	1/4	P28-4	P28-6			P28-10	P28-10 OS		P28-14	P28-14 OS
7/16	.4370	11/16	1/4	P29-4	P29-6			P29-10	P29-10 OS		P29-14	P29-14 OS
29/64	.4526	45/64	1/4	P30-4	P30-6			P30-10	P30-10 OS		P30-14	P30-14 OS
15/32	.4683	3/4	1/4	P31-4	P31-6			P31-10	P31-10 OS		P31-14	P31-14 OS
31/64	.4839	3/4	1/4	P32-4	P32-6			P32-10	P32-10 OS		P32-14	P32-14 OS
1/2	.4995	3/4	1/4	P33-4	P33-6	P33-6 OS	P33-8	P33-10	P33-10 OS	P33-12	P33-14	P33-14 OS
17/32	.5307	25/32	1/4	P34-4	P34-6	P34-6 OS	P34-8	P34-10	P34-10 OS	P34-12	P34-14	P34-14 OS
9/16	.5620	13/16	1/4	P35-4	P35-6	P35-6 OS	P35-8	P35-10	P35-10 OS	P35-12	P35-14	P35-14 OS
5/8	.6245	7/8	1/4	P37-4	P37-6	P37-6 OS	P37-8	P37-10	P37-10 OS	P37-12	P37-14	P37-14 OS
11/16	.6870	15/16	1/4	P39-4	P39-6	P39-6 OS	P39-8	P39-10	P39-10 OS	P39-12	P39-14	P39-14 OS
3/4	.7495	1	1/4	P41-4	P41-6	P41-6 OS	P41-8	P41-10	P41-10 OS	P41-12	P41-14	P41-14 OS
7/8	.8745	1-1/8	1/4	P45-4	P45-6	P45-6 OS	P45-8	P45-10	P45-10 OS	P45-12	P45-14	P45-14 OS
1	.9995	1-1/4	1/4	P47-4	P47-6	P47-6 OS	P47-8	P47-10	P47-10 OS	P47-12	P47-14	P47-14 OS

## Hardened Throughtout® Ejector Pins - Oversized

- Can be used as an ejector or core pin
- Pins 6" and longer have annealed heads to minimize brittleness and allow for easier machining
- All pin sizes with diameter greater than 3/32" are etched for identification

SPECIFICATIONS	
R Pin to Head Radius	R.030
Core Hardness	48 - 55 Rc
Surface Hardness	65 - 74 Rc
Material Type	Premium Hot Work Steel
Unit of Measure	Inch

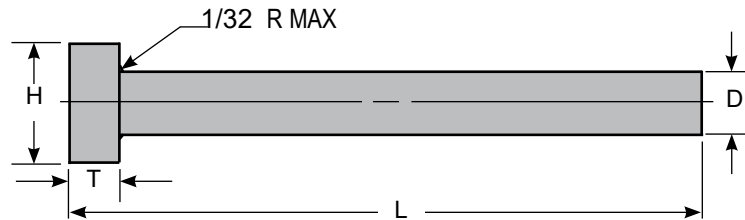

CATALOG NO.	ACTUAL PIN DIAMETER +.0000 / -.0003	D NOMINAL PIN DIAMETER	H HEAD DIAMETER +.000 / -.010	T HEAD THICKNESS +.000 / -.002	L OVERALL LENGTH +.062 / -.000	OVERSIZE INCREMENTS
P9-8 OS-1	.1255	1/8	1/4	1/8	8	.001 Oversize
P9-8 OS-2	.1265					.002 Oversize
P9-8 OS-3	.1275					.003 Oversize
P9-8 OS-4	.1285					.004 Oversize
P11-8 OS-1	.1567	5/32	9/32	5/32		.001 Oversize
P11-8 OS-2	.1577					.002 Oversize
P11-8 OS-3	.1587					.003 Oversize
P11-8 OS-4	.1597					.004 Oversize
P13-8 OS-1	.1880	3/16	3/8	3/16		.001 Oversize
P13-8 OS-2	.1890					.002 Oversize
P13-8 OS-3	.1900					.003 Oversize
P13-8 OS-4	.1910					.004 Oversize
P17-8 OS-1	.2505	1/4	7/16	3/16		.001 Oversize
P17-8 OS-2	.2515					.002 Oversize
P17-8 OS-3	.2525					.003 Oversize
P17-8 OS-4	.2535					.004 Oversize
P17-8 OS-6	.2555				.006 Oversize	
P17-8 OS-7	.2565				.007 Oversize	
P17-8 OS-8	.2575				.008 Oversize	

## Hardened Throughtout® Ejector Pins - D-Head

- Designed to prevent pin rotation
- No secondary machining required
- Pins 6" and longer have annealed heads to minimize brittleness and allow for easier machining
- Precision ground to 4 - 10 micro-inch finish



### SPECIFICATIONS

R Pin to Head Radius	R.030
Core Hardness	48 - 55 Rc
Surface Hardness	65 - 74 Rc
Material Type	Premium Hot Work Steel
Unit of Measure	Inch

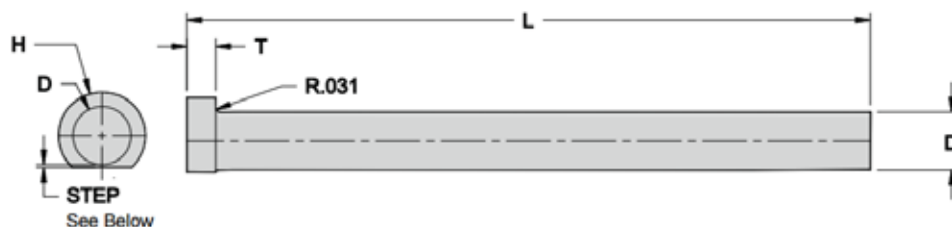

### D PIN DIAMETER TOLERANCES

DHP7 - DHP33	+ .0000 / - .0003
DHP35 - DHP47	+ .0000 / - .0005

D PIN DIA.	ACTUAL SIZE	H HEAD DIA. +.000 -.010	T HEAD THICK. +.000 -.002	STEP TOLERANCE	L OVERALL LENGTH +.062 / -.000							
					4"	6"	8"	10"	12"	14"		
3/32	.0933	7/32	1/8	.006 +/- .002	DHP7-4	DHP7-6						
1/8	.1245	1/4				DHP9-6		DHP9-10	DHP9-12	DHP9-14		
9/64	.1401	1/4						DHP10-10				
5/32	.1557	9/32	5/32			DHP11-6	DHP11-8	DHP11-10		DHP11-14		
3/16	.1870	3/8	3/16			DHP13-6	DHP13-8	DHP13-10	DHP13-12	DHP13-14		
7/32	.2183	13/32				DHP15-6	DHP15-8	DHP15-10		DHP15-14		
1/4	.2495	7/16			DHP17-4	DHP17-6	DHP17-8	DHP17-10		DHP17-14		
9/32	.2807	7/16	1/4		.007 +/- .003				DHP19-10			
5/16	.3120	1/2				DHP21-4			DHP21-10	DHP21-12	DHP21-14	
11/32	.3433	9/16							DHP23-10			
3/8	.3745	5/8					DHP25-6	DHP25-8	DHP25-10		DHP25-14	
13/32	.4057	11/16					DHP27-4	DHP27-6		DHP27-10		
7/16	.4370	11/16						DHP29-6		DHP29-10		
1/2	.4995	3/4					DHP33-4	DHP33-6	DHP33-8	DHP33-10	DHP33-12	DHP33-14
9/16	.5620	13/16						DHP35-6	DHP35-8	DHP35-10	DHP35-12	
5/8	.6245	7/8					DHP37-4	DHP37-6		DHP37-10		DHP37-14
3/4	.7495	1						DHP41-6		DHP41-10		DHP41-14
7/8	.8745	1-1/8						DHP45-6	DHP45-8			
1	.9995	1-1/4						DHP47-6		DHP47-10	DHP47-12	DHP47-14

To order D-Head Ejector Pins with the flat ground tangent to the pin diameter, specify "T" after the PCS part number (Ex: DHP9-6T)

## Hardened Throughtout® Step Pins

- Shoulder lengths of 1/2", 2", 3" and 4"
- Pins 6" and longer have annealed heads to minimize brittleness and allow for easier machining
- All pin sizes with diameter greater than 3/32" are etched for identification



SPECIFICATIONS	
Head Diameter Tolerance	+ .000 / - .010
Shoulder Diameter Tolerance	+ .000 / - .001
Head Thickness Tolerance	+ .000 / - .002
Core Hardness	48 - 55 Rc
Surface Hardness	65 - 74 Rc
Material Type	Premium Hot Work Steel
Unit of Measure	Inch

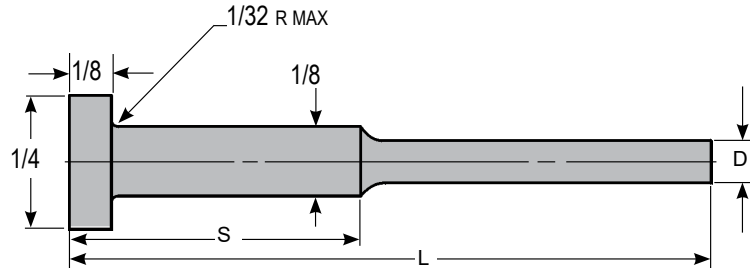

D NOMINAL PIN DIA.	ACTUAL PIN DIA. + .000 / - .0003	S SHOULDER LENGTH + .010 / - .010	L OVERALL LENGTH + .062 / - .000			
			6"	8"	10"	14"
1/32	.0307	1/2	SP3-6 1/2			
		2	SP3-62	SP3-82		SP3-142
		3		SP3-83		
		4		SP3-84		
3/64	.0464	1/2	SP4-6 1/2			
		2	SP4-62	SP4-82	SP4-102	
		3		SP4-83		
		4		SP4-84	SP4-104	
1/16	.0620	1/2	SP5-6 1/2		SP5-10 1/2	
		2	SP5-62	SP5-82	SP5-102	SP5-142
		3		SP5-83		
		4		SP5-84	SP5-104	
5/64	.0776	1/2	SP6-6 1/2		SP6-10 1/2	SP6-14 1/2
		2	SP6-62		SP6-102	SP6-142
		3		SP6-83		
		4		SP6-84	SP6-104	
3/32	.0933	1/2	SP7-6 1/2		SP7-10 1/2	SP7-14 1/2
		2	SP7-62	SP7-82	SP7-102	SP7-142
		3		SP7-83		
		4		SP7-84	SP7-104	
7/64	.1089	1/2	SP8-6 1/2		SP8-10 1/2	
		2	SP8-62	SP8-82	SP8-102	SP8-142
		3		SP8-83		
		4		SP8-84	SP8-104	

## Hardened Throughtout® Step Pins - D-Head

- Designed to prevent pin rotation
- No secondary machining required
- Precision ground to 4 - 10 micro-inch finish



SPECIFICATIONS	
Annealed Head	Yes
R Pin to Head Radius	R.030
SD Shoulder Diameter	.125
Step Tolerance	.006 + .002
Core Hardness	48 - 55 Rc
Surface Hardness	65 - 74 Rc
Etched for Identification	Yes
Material Type	Premium Hot Work Steel
Unit of Measure	Inch

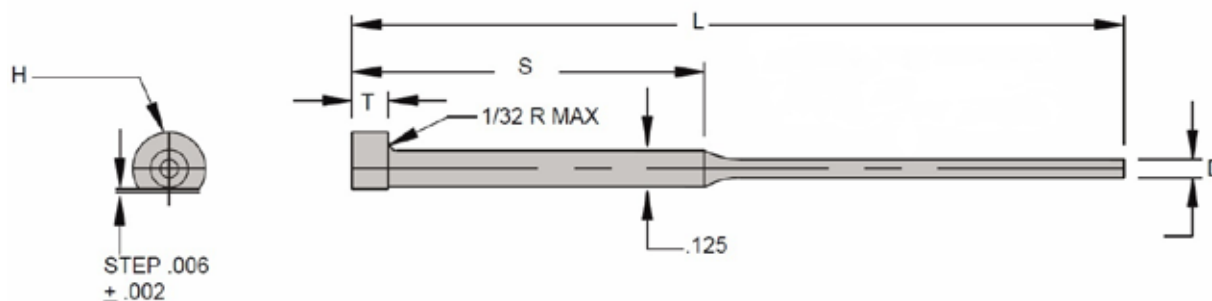

CATALOG NO.	ACTUAL PIN DIAMETER +.000 / -.0003	D NOMINAL PIN DIA.	H HEAD DIAMETER	T HEAD THICKNESS	S SHOULDER LENGTH	L OVERALL LENGTH
DSP3-62	.0307	1/32	1/4	1/8	2	6
DSP4-62	.0464	3/64	1/4	1/8	2	6
DSP5-62	.0620	1/16	1/4	1/8	2	6
DSP6-62	.0776	5/64	1/4	1/8	2	6
DSP6-83	.0776	5/64	1/4	1/8	2	6
DSP7-62	.0933	3/32	1/4	1/8	2	6
DSP8-62	.1089	7/64	1/4	1/8	2	6
DSP8-102	.1089	7/64	1/4	1/8	2	10



# Hardened Throughtout® Step Pins - .005 Oversized

- Shoulder lengths of 1/2", 2", 3" and 4"
- Pins 6" and longer have annealed heads to minimize brittleness and allow for easier machining
- All pin sizes with diameter greater than 3/32" are etched for identification

SPECIFICATIONS	
Head Diameter Tolerance	+ .000 / - .010
Shoulder Diameter Tolerance	+ .000 / - .001
Head Thickness Tolerance	+ .000 / - .002
Core Hardness	48 - 55 Rc
Surface Hardness	65 - 74 Rc
Material Type	Premium Hot Work Steel
Unit of Measure	Inch

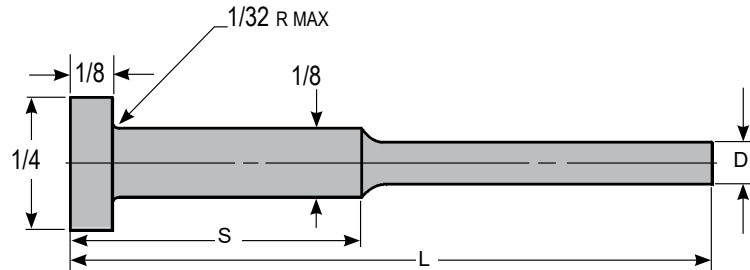

D NOMINAL PIN DIA.	ACTUAL PIN DIAMETER + .000 / - .0003	S SHOULDER LENGTH + .010 / - .010	L OVERALL LENGTH + .062 / - .000			
			6"	8"	10"	14"
			.005 OS	.005 OS	.005 OS	.005 OS
1/32	.0307	1/2	SP3-6 1/2 OS			
		2	SP3-62 OS			
		3		SP3-83 OS		
		4		SP3-84 OS		
3/64	.0464	1/2	SP4-6 1/2 OS			
		2	SP4-62 OS		SP4-102 OS	
		3		SP4-83 OS		
		4		SP4-84 OS	SP4-104 OS	
1/16	.0620	1/2	SP5-6 1/2 OS		SP5-10 1/2 OS	
		2	SP5-62 OS		SP5-102 OS	SP5-142 OS
		3		SP5-83 OS		
		4		SP5-84 OS	SP5-104 OS	
5/64	.0776	1/2	SP6-6 1/2 OS		SP6-10 1/2 OS	
		2	SP6-62 OS		SP6-102 OS	SP6-142 OS
		3		SP6-83 OS		
		4		SP6-84 OS	SP6-104 OS	
3/32	.0933	1/2	SP7-6 1/2 OS		SP7-10 1/2 OS	
		2	SP7-62 OS		SP7-102 OS	SP7-142 OS
		3		SP7-83 OS		
		4		SP7-84 OS	SP7-104 OS	
7/64	.1089	1/2	SP8-6 1/2 OS		SP8-10 1/2 OS	
		2	SP8-62 OS		SP8-102 OS	SP8-142 OS
		3		SP8-83 OS		
		4		SP8-84 OS	SP8-104 OS	

## Hardened Throughtout® Step Pins - Oversized

- .001 increments oversized
- Reduces “dishing” effect common to nitrided pins
- All pin sizes with diameter greater than 3/32 are etched for identification.



SPECIFICATIONS	
Head Diameter Tolerance	+ .000 / -.010
Shoulder Diameter Tolerance	+ .000 / -.001
Head Thickness Tolerance	+ .000 / -.002
Overall Length	8
Core Hardness	48 - 55 Rc
Surface Hardness	65 - 74 Rc
Material Type	Premium Hot Work Steel
Unit of Measure	Inch

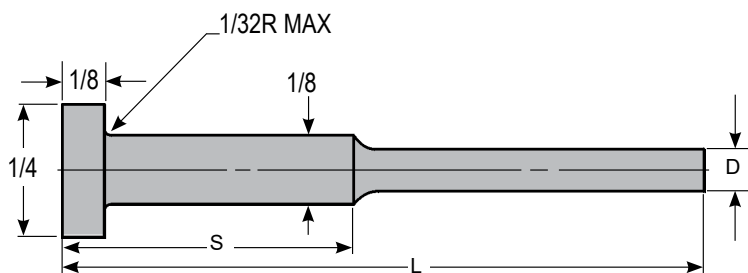

D NOMINAL PIN DIA.	ACTUAL PIN DIAMETER +.000 / -.0003	S SHOULDER LENGTH +.010 / -.010	L OVERALL LENGTH = 8" +.062 / -.000			
			.001 OS	.002 OS	.003 OS	.004 OS
1/32	.0307	2	SP3-82 OS-1	SP3-82 OS-2	SP3-82 OS-3	SP3-82 OS-4
3/64	.0464	1/2	SP4-8 1/2 OS-1	SP4-8 1/2 OS-2	SP4-8 1/2 OS-3	SP4-8 1/2 OS-4
		2	SP4-82 OS-1	SP4-82 OS-2	SP4-82 OS-3	SP4-82 OS-4
1/16	.0620	1/2	SP5-8 1/2 OS-1	SP5-8 1/2 OS-2	SP5-8 1/2 OS-3	SP5-8 1/2 OS-4
		2	SP5-82 OS-1	SP5-82 OS-2	SP5-82 OS-3	SP5-82 OS-4
5/64	.0776	1/2	SP6-8 1/2 OS-1	SP6-8 1/2 OS-2	SP6-8 1/2 OS-3	SP6-8 1/2 OS-4
		2	SP6-82 OS-1	SP6-82 OS-2	SP6-82 OS-3	SP6-82 OS-4
3/32	.0933	1/2	SP7-8 1/2 OS-1	SP7-8 1/2 OS-2	SP7-8 1/2 OS-3	SP7-8 1/2 OS-4
		2	SP7-82 OS-1	SP7-82 OS-2	SP7-82 OS-3	SP7-82 OS-4
7/64	.1089	2	SP8-82 OS-1	SP8-82 OS-2	SP8-82 OS-3	SP8-82 OS-4

## Nitrided Ejector Pins

- Precision ground hotwork steel
- 4 - 10 micro-inch finish minimizes wear & prolongs life
- All heads annealed
- All pin sizes with diameter greater than 3/32" are etched for identification

SPECIFICATIONS	
R Pin to Head Radius	R.030
Core Hardness	40 - 45 Rc
Surface Hardness	65 - 74 Rc
Material Type	Hot Work Tool Steel
Unit of Measure	Inch



D PIN DIAMETER TOLERANCES	
NP3 - NP33	+.0000/- .0003
NP35 - NP47	+.0000/- .0005

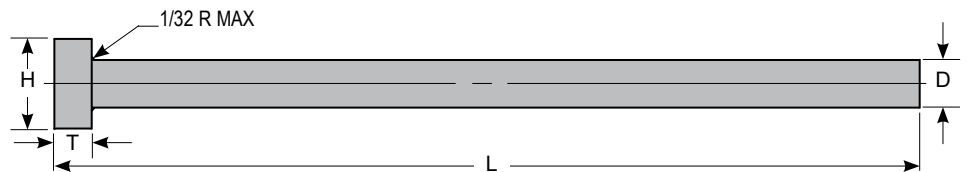

D PIN DIA.	ACTUAL SIZE	H HEAD DIA. +.000 -.010	T HEAD THICK. +.000 -.002	L OVERALL LENGTH +.062 / -.000							
				6"	10"	14"	18"	25"	36"	39"	
1/32	.0307	1/8	1/8	NP3-6							
1/16	.0620	3/16	1/8	NP5-6							
5/64	.0776	13/64	1/8	NP6-6	NP6-10						
3/32	.0933	7/32	1/8	NP7-6	NP7-10						
7/64	.1089	15/64	1/8	NP8-6	NP8-10						
1/8	.1245	1/4	1/8	NP9-6	NP9-10	NP9-14	NP9-18	NP9-25			
9/64	.1401	1/4	1/8		NP10-10	NP10-14					
5/32	.1557	9/32	5/32	NP11-6	NP11-10	NP11-14	NP11-18	NP11-25			
11/64	.1714	11/32	3/16		NP12-10	NP12-14					
3/16	.1870	3/8	3/16	NP13-6	NP13-10	NP13-14	NP13-18	NP13-25			NP13-39
13/64	.2026	3/8	3/16		NP14-10	NP14-14					
7/32	.2183	13/32	3/16	NP15-6	NP15-10	NP15-14		NP15-25			
15/64	.2339	13/32	3/16		NP16-10	NP16-14					
1/4	.2495	7/16	3/16	NP17-6	NP17-10	NP17-14	NP17-18	NP17-25	NP17-36	NP17-39	
17/64	.2651	7/16	1/4		NP18-10	NP18-14		NP18-25			
9/32	.2807	7/16	1/4	NP19-6	NP19-10	NP19-14	NP19-18	NP19-25			
19/64	.2964	1/2	1/4		NP20-10	NP20-14					
5/16	.3120	1/2	1/4	NP21-6	NP21-10	NP21-14	NP21-18	NP21-25	NP21-36		
21/64	.3276	9/16	1/4		NP22-10	NP22-14		NP22-25			
11/32	.3433	9/16	1/4	NP23-6	NP23-10	NP23-14		NP23-25			
23/64	.3589	5/8	1/4		NP24-10	NP24-14					
3/8	.3745	5/8	1/4	NP25-6	NP25-10	NP25-14	NP25-18	NP25-25	NP25-36	NP25-39	
13/32	.4057	11/16	1/4	NP27-6	NP27-10	NP27-14	NP27-18	NP27-25			
7/16	.4370	11/16	1/4	NP29-6	NP29-10	NP29-14	NP29-18	NP29-25	NP29-36		
15/32	.4683	3/4	1/4		NP31-10		NP31-18	NP31-25			
1/2	.4995	3/4	1/4	NP33-6	NP33-10	NP33-14	NP33-18	NP33-25	NP33-36	NP33-39	
9/16	.5620	13/16	1/4	NP35-6	NP35-10	NP35-14	NP35-18	NP35-25			
5/8	.6245	7/8	1/4	NP37-6	NP37-10	NP37-14	NP37-18	NP37-25	NP37-36	NP37-39	
11/16	.6870	15/16	1/4		NP39-10		NP39-18	NP39-25			
3/4	.7495	1	1/4	NP41-6	NP41-10	NP41-14	NP41-18	NP41-25	NP41-36	NP41-39	
7/8	.8745	1-1/8	1/4		NP45-10		NP45-18	NP45-25			
1	.9995	1-1/4	1/4	NP47-6	NP47-10	NP47-14	NP47-18	NP47-25	NP47-36	NP47-39	

## Nitrided Ejector Pins - Oversized

- Precision ground hotwork steel
- 4 - 10 micro-inch finish minimizes wear & prolongs life
- All heads annealed
- All pin sizes with diameter greater than 3/32" are etched for identification



SPECIFICATIONS	
R Pin to Head Radius	R.030
Core Hardness	40 - 45 Rc
Surface Hardness	65 - 74 Rc
Material Type	Hot Work Tool Steel
Unit of Measure	Inch

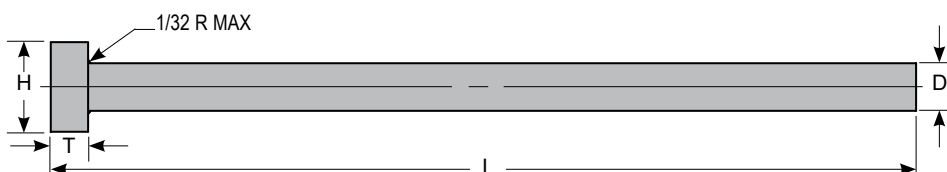

D PIN DIA.	ACTUAL SIZE +.0005/- .0008	H HEAD DIA. +.000 /-.010	T HEAD THICK. +.000 /-.002	L OVERALL LENGTH +.062 / -.000		
				10" .005 OS	14" .005 OS	18" .005 OS
1/8	.1245	1/4	1/8	NP9-10 OS	NP9-14 OS	
9/64	.1401	1/4	1/8			
5/32	.1557	9/32	5/32	NP11-10 OS	NP11-14 OS	
11/64	.1714	11/32	3/16			
3/16	.1870	3/8	3/16	NP13-10 OS	NP13-14 OS	
13/64	.2026	3/8	3/16			
7/32	.2183	13/32	3/16	NP15-10 OS		
15/64	.2339	13/32	3/16			
1/4	.2495	7/16	3/16	NP17-10 OS	NP17-14 OS	NP17-18 OS
17/64	.2651	7/16	1/4			
9/32	.2807	7/16	1/4	NP19-10 OS		
19/64	.2964	1/2	1/4			
5/16	.3120	1/2	1/4	NP21-10 OS	NP21-14 OS	NP21-18 OS
21/64	.3276	9/16	1/4			
11/32	.3433	9/16	1/4	NP23-10 OS		
23/64	.3589	5/8	1/4			
3/8	.3745	5/8	1/4	NP25-10 OS	NP25-14 OS	NP25-18 OS
13/32	.4057	11/16	1/4	NP27-10 OS		
7/16	.4370	11/16	1/4	NP29-10 OS	NP29-14 OS	
15/32	.4683	3/4	1/4	NP31-10 OS		
1/2	.4995	3/4	1/4	NP33-10 OS	NP33-14 OS	

## Nitrided Ejector Pins - D-Head

- Designed to prevent pin rotation
- Manufactured from premium hot work steel
- Annealed heads
- All pin sizes with diameter greater than 3/32 are etched for identification.
- Precision ground to 4 - 10 micro-inch finish

SPECIFICATIONS	
R Pin to Head Radius	R.030
Core Hardness	40 - 45 Rc
Surface Hardness	65 - 74 Rc
Material Type	Hot Work Tool Steel
Unit of Measure	Inch

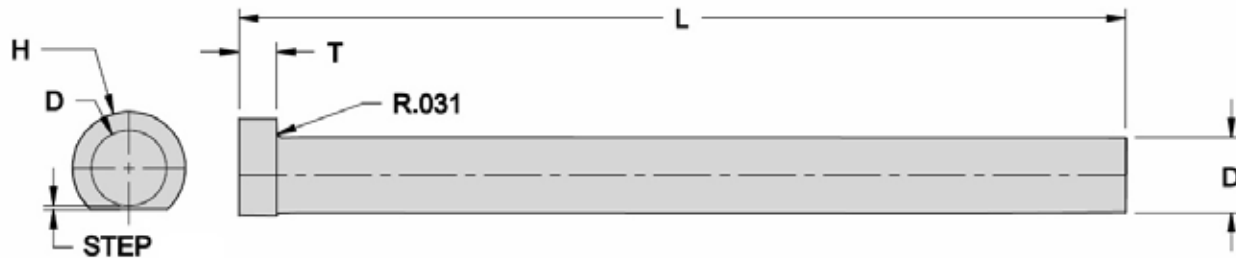

D PIN DIA. +.000 -.001	ACTUAL SIZE	H HEAD DIA. +.000 -.010	T HEAD THICK. +.000 -.002	STEP TOLERANCE	L OVERALL LENGTH +.062 / -.000				
					6"	10"	14"	18"	25"
1/8	.1245	1/4	1/8	.006 +/- .002	DNP9-6	DNP9-10	DNP9-14		
5/32	.1557	9/32	5/32		DNP11-6	DNP11-10	DNP11-14	DNP11-18	DNP11-25
3/16	.1870	3/8	3/16		DNP13-6	DNP13-10	DNP13-14	DNP13-18	DNP13-25
7/32	.2183	13/32	3/16						DNP15-25
1/4	.2495	7/16	3/16		DNP17-6	DNP17-10	DNP17-14	DNP17-18	DNP17-25
5/16	.3120	1/2	3/16		DNP21-6	DNP21-10	DNP21-14	DNP21-18	DNP21-25
3/8	.3745	5/8	1/4	.007 +/- .003	DNP25-6	DNP25-10	DNP25-14	DNP25-18	DNP25-25
1/2	.4995	3/4	1/4		DNP33-6	DNP33-10	DNP33-14	DNP33-18	DNP33-25
5/8	.6245	7/8	1/4		DNP37-6	DNP37-10	DNP37-14	DNP37-18	DNP37-25
3/4	.8745	1	1/4		DNP41-6	DNP41-10	DNP41-14	DNP41-18	DNP41-25
1	.9995	1-1/4	1/4		DNP47-6	DNP47-10	DNP47-14	DNP47-18	DNP47-25

To order D-Head Ejector Pins with the flat ground tangent to the pin diameter, specify "T" after the PCS part number (Ex: DNP9-6T)

## Armor Coated Ejector Pins

- Surface treatment reduces wear, friction, and inhibits corrosion
- Enhances metal hardness, adds lubricity
- Coating thickness of 5 to 7 microns
- All pin sizes with diameter greater than 3/32" are etched for identification
- Pins 6" and longer have annealed heads to minimize brittleness and allow for easier machining



SPECIFICATIONS	
Coating Thickness	0.000050 - 0.000070
Coating Type	Armor Coated
Core Hardness	48 - 55 Rc
Surface Hardness	65 - 74 Rc
Material Type	Premium Hot Work Steel
Unit of Measure	Inch

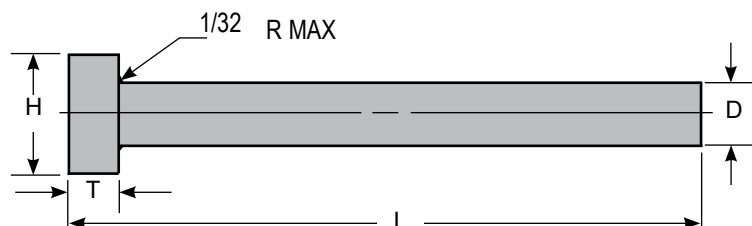

D PIN DIAMETER TOLERANCES	
AR3 - AR33	+ .0000 / - .0003
AR34 - AR47	+ .0000 / - .0005

CATALOG NO.	D PIN DIA.	ACTUAL SIZE +.0000 -.0003	H HEAD DIA. +.000 -.010	T HEAD THICK. +.000 -.002	L OVERALL LENGTH +.062 / -.000									
					4"	6"	8"	10"	12"	14"	18"	25"	36"	
AR3-	1/32	.0307	1/8	1/8		•								
AR4-	3/64	.0464	5/32	1/8		•								
AR5-	1/16	.0620	3/16	1/8	•	•		•						
AR6-	5/64	.0776	13/64	1/8		•								
AR7-	3/32	.0933	7/32	1/8		•	•	•						
AR8-	7/64	.1089	15/64	1/8	•			•						
AR9-	1/8	.1245	1/4	1/8		•		•	•	•	•			
AR10-	9/64	.1401	1/4	1/8				•		•				
AR11-	5/32	.1557	9/32	5/32		•		•	•	•	•	•		
AR12-	11/64	.1714	11/32	3/16				•						
AR13-	3/16	.1870	3/8	3/16		•	•	•	•	•	•	•		
AR14-	13/64	.2026	3/8	3/16		•		•		•				
AR15-	7/32	.2183	13/32	3/16		•		•		•		•		
AR16-	15/64	.2339	13/32	3/16				•		•				
AR17-	1/4	.2495	7/16	3/16		•	•	•	•	•	•	•	•	•
AR18	17/64	.2651	7/16	1/4		•		•		•				
AR19-	9/32	.2807	7/16	1/4	•	•		•		•	•			
AR20-	19/64	.2964	1/2	1/4		•		•		•				

Add length to catalog number (I.E. AR3-6)

Continued on next page

## Armor Coated Ejector Pins

- Surface treatment reduces wear, friction, and inhibits corrosion
- Enhances metal hardness, adds lubricity
- Coating thickness of 5 to 7 microns
- All pin sizes with diameter greater than 3/32" are etched for identification
- Pins 6" and longer have annealed heads to minimize brittleness and allow for easier machining

SPECIFICATIONS	
Coating Thickness	0.000050 - 0.000070
Coating Type	Armor Coated
Core Hardness	48 - 55 Rc
Surface Hardness	65 - 74 Rc
Material Type	Premium Hot Work Steel
Unit of Measure	Inch



D PIN DIAMETER TOLERANCES	
AR3 - AR33	+0.0000/-0.0003
AR34 - AR47	+0.0000/-0.0005

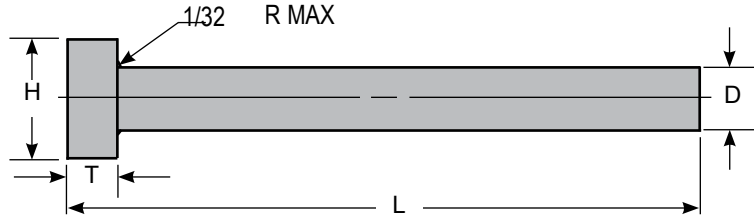

CATALOG NO.	D PIN DIA.	ACTUAL SIZE +.0000 -.0003	H HEAD DIA. +.000 -.010	T HEAD THICK. +.000 -.002	L OVERALL LENGTH +.062 / -.000									
					4"	6"	8"	10"	12"	14"	18"	25"	36"	
AR21-	5/16	.3120	1/2	1/4		•	•	•	•	•	•	•		
AR22-	21/64	.3276	9/16	1/4						•				
AR23-	11/32	.3433	9/16	1/4	•	•		•		•				
AR24-	23/64	.3589	5/8	1/4				•		•				
AR25-	3/8	.3745	5/8	1/4		•		•	•	•	•	•	•	•
AR26-	25/64	.3901	37/64	1/4		•		•						
AR27-	13/32	.4057	11/16	1/4		•				•				
AR29-	7/16	.4370	11/16	1/4	•	•		•		•	•	•		
AR30-	29/64	.4526	45/64	1/4				•						
AR33-	1/2	.4995	3/4	1/4		•		•	•	•	•	•	•	•
AR34-	17/32	.5307	25/32	1/4				•						
AR35-	9/16	.5620	13/16	1/4		•		•		•				
AR37-	5/8	.6245	7/8	1/4		•		•		•	•	•		
AR39-	11/16	.6870	15/16	1/4								•		
AR41-	3/4	.7495	1	1/4		•		•	•	•	•	•	•	
AR45-	7/8	.8745	1-1/8	1/4							•			
AR47-	1	.9995	1-1/4	1/4			•	•		•	•	•	•	•

Add length to catalog number (I.E. AR21-6)

## Armor Coated Ejector Pins - Oversized

- Surface treatment reduces wear, friction, and inhibits corrosion
- Enhances metal hardness, adds lubricity
- All pin sizes with diameter greater than 3/32" are etched for identification
- Pins 6" and longer have annealed heads to minimize brittleness and allow for easier machining



SPECIFICATIONS	
Coating Thickness	0.000050 - 0.000070
Coating Type	Armor Coated
Core Hardness	48 - 55 Rc
Material Type	Premium Hot Work Steel
Surface Hardness	65 - 74 Rc
Unit of Measure	Inch

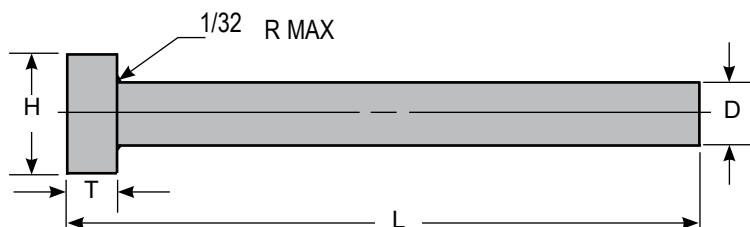

D PIN DIAMETER TOLERANCES	
AR5 - AR33	+0.0000/-0.0003
AR37 - AR41	+0.0000/-0.0005

D PIN DIA.	ACTUAL SIZE	H HEAD DIA. +.000 /-.010	T HEAD THICK. +.000 /-.002	L OVERALL LENGTH +.062 / -.000		
				6" .005 OS	10" .005 OS	14" .005 OS
1/16	.067	3/16	1/8		AR5-10 OS	
5/64	.0826	13/64	1/8		AR6-10 OS	
3/32	.0983	7/32	1/8		AR7-10 OS	
7/64	.1139	15/64	1/8		AR8-10 OS	
1/8	.1295	1/4	1/8	AR9-6 OS	AR9-10 OS	AR9-14 OS
9/64	.1451	1/4	1/8	AR10-6 OS	AR10-10 OS	
5/32	.1607	9/32	5/32	AR11-6 OS	AR11-10 OS	AR11-14 OS
11/64	.1764	11/32	3/16		AR12-10 OS	
3/16	.1920	3/8	3/16	AR13-6 OS	AR13-10 OS	AR13-14 OS
13/64	.2076	3/8	3/16		AR14-10 OS	
7/32	.2233	13/32	3/16	AR15-6 OS	AR15-10 OS	AR15-14 OS
15/64	.2389	13/32	3/16		AR16-10 OS	
1/4	.2545	7/16	3/16	AR17-6 OS	AR17-10 OS	AR17-14 OS

Continued on next page



## Armor Coated Ejector Pins - Oversized

- Surface treatment reduces wear, friction, and inhibits corrosion
- Enhances metal hardness, adds lubricity
- All pin sizes with diameter greater than 3/32" are etched for identification
- Pins and longer have annealed heads to minimize brittleness and allow for easier machining

SPECIFICATIONS	
Coating Thickness	0.000050 - 0.000070
Coating Type	Armor Coated
Core Hardness	48 - 55 Rc
Material Type	Premium Hot Work Steel
Surface Hardness	65 - 74 Rc
Unit of Measure	Inch



D PIN DIAMETER TOLERANCES	
AR5 - AR33	+0.0000/-0.0003
AR37 - AR41	+0.0000/-0.0005

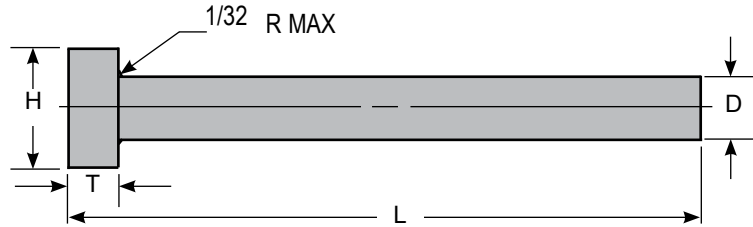

D PIN DIA.	ACTUAL SIZE	H HEAD DIA. +.000 /-.010	T HEAD THICK. +.000 /-.002	L OVERALL LENGTH +.062 / -.000		
				6" .005 OS	10" .005 OS	14" .005 OS
17/64	.2701	7/16	1/4	AR18-6 OS	AR18-10 OS	
9/32	.2857	7/16	1/4	AR19-6 OS	AR19-10 OS	
19/64	.3014	1/2	1/4		AR20-10 OS	
5/16	.3170	1/2	1/4		AR21-10 OS	AR21-14 OS
21/64	.3326	9/16	1/4		AR22-10 OS	
11/32	.3433	9/16	1/4		AR23-10 OS	
3/8	.3795	5/8	1/4		AR25-10 OS	AR25-14 OS
7/16	.4420	11/16	1/4		AR29-10 OS	AR29-14 OS
1/2	.5045	3/4	1/4		AR33-10 OS	AR33-14 OS
5/8	.6295	7/8	1/4			AR37-14 OS
11/16	.6920	15/16	1/4			AR39-14 OS
3/4	.7545	1	1/4			AR41-14 OS

## Armor Coated Step Pins

- Surface treatment reduces wear, friction, and inhibits corrosion
- All pin sizes with diameter greater than 3/32" are etched for identification
- Pins 6" and longer have annealed heads to minimize brittleness and allow for easier machining



SPECIFICATIONS	
Head Diameter Tolerance	+ .000 / - .010
Shoulder Diameter Tolerance	+ .000 / - .001
Head Thickness Tolerance	+ .000 / - .002
Coating Thickness	0.000050 - 0.000070
Coating Type	Armor Coated
Core Hardness	48 - 55 Rc
Surface Hardness	65 - 74 Rc
Material Type	Premium Hot Work Steel
Unit of Measure	Inch

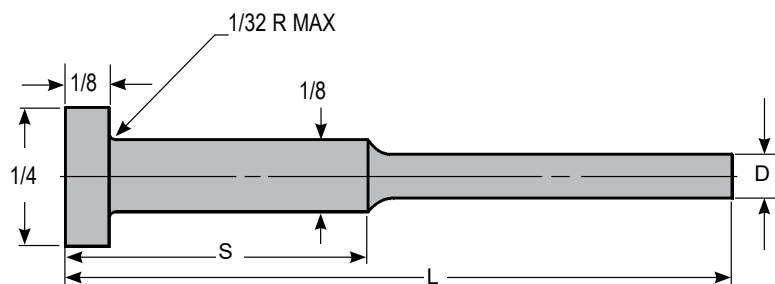

D NOMINAL PIN DIA.	ACTUAL PIN DIA. +.0000 -.0003	S SHOULDER LENGTH +.010 / -.010	L OVERALL LENGTH +.062 / -.000			
			6"	8"	10"	14"
1/32	.0307	1/2	ARS3-6 1/2			
		2	ARS3-62	ARS3-82		
		3		ARS3-83		
		4		ARS3-84		
3/64	.0464	1/2	ARS4-6 1/2			
		2	ARS4-62	ARS4-82	ARS4-102	
		3		ARS4-83		
		4		ATS4-84	ARS4-104	
1/16	.0620	1/2	ARS5-6 1/2		ARS5-10 1/2	
		2	ARS5-62		ARS5-102	ARS5-142
		3		ARS5-83		
		4		ARS5-84	ARS5-104	
5/64	.0776	1/2	ARS6-6 1/2			
		2	ARS6-62		ARS6-102	
		3		ARS6-83		
		4		ARS6-84	ARS6-104	
3/32	.0933	1/2	ARS7-6 1/2			
		2	ARS7-62		ARS7-102	ARS7-142
		3		ARS7-83		
		4		ARS7-84	ARS7-104	
7/64	.1089	1/2	ARS8-6 1/2			
		2	ARS8-62		ARS8-102	ARS8-142

## Armor Coated Step Pins - Oversized

- Surface treatment reduces wear, friction, and inhibits corrosion
- Enhanced metal hardness and added lubricity
- All pin sizes with diameter greater than 3/32" are etched for identification
- Pins 6" and longer have annealed heads to minimize brittleness and allow for easier machining

SPECIFICATIONS	
Head Diameter Tolerance	+ .000 / - .010
Shoulder Diameter Tolerance	+ .000 / - .001
Head Thickness Tolerance	+ .000 / - .002
Coating Thickness	0.000050 - 0.000070
Coating Type	Armor Coated
Core Hardness	48 - 55 Rc
Surface Hardness	65 - 74 Rc
Material Type	Premium Hot Work Steel
Unit of Measure	Inch

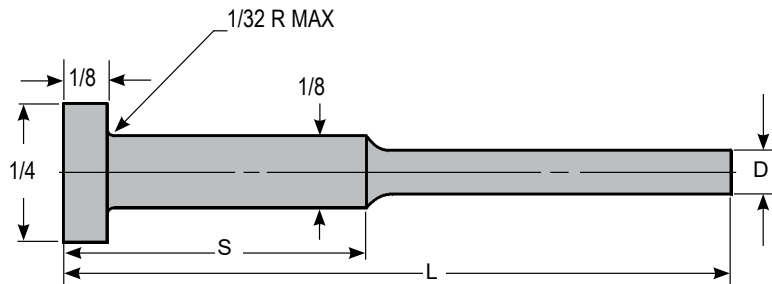

D NOMINAL PIN DIA.	ACTUAL PIN DIA. +.0000 -.0003	S SHOULDER LENGTH +.010 / -.010	L OVERALL LENGTH +.062 / -.000		
			6" .005 OS	8" .005 OS	10" .005 OS
1/32	.0307	1/2	ARS3-6 1/2 OS		
		2	ARS3-62 OS	ARS3-82 OS	
		3		ARS3-83 OS	
3/64	.0464	1/2	ARS4-6 1/2 OS		
		2	ARS4-62 OS		ARS4-102 OS
1/16	.0620	1/2	ARS5-6 1/2 OS		
		2	ARS5-62 OS		ARS5-102 OS
		4			ARS5-104 OS
5/64	.0776	1/2	ARS6-6 1/2 OS		
		2	ARS6-62 OS		ARS6-102 OS
		3		ARS6-83 OS	
3/32	.0933	1/2	ARS7-6 1/2 OS		
		2	ARS7-62 OS		
7/64	.1089	1/2	ARS8-6 1/2 OS		
		2	ARS8-62 OS		ARS8-102 OS

# Ejector Blades

- One piece construction to improve strength
- Blades are etched for identification
- Corner radius on blade cross-section can be special ordered



SPECIFICATIONS	
Core Hardness	50 - 52 Rc
Surface Hardness	50 - 52 Rc
Material Type	Hot Work Tool Steel
Unit of Measure	Inch

CATALOG NO.	W BLADE WIDTH +.0000 -.0003	A PIN DIA. +.000 -.001	H HEAD DIA. +.000 -.010	T HEAD THICK. +.000 -.002
BE9-	.100	.125	1/4	1/8
BE11-	.140	.156	9/32	5/32
BE13-	.172	.187	3/8	3/16

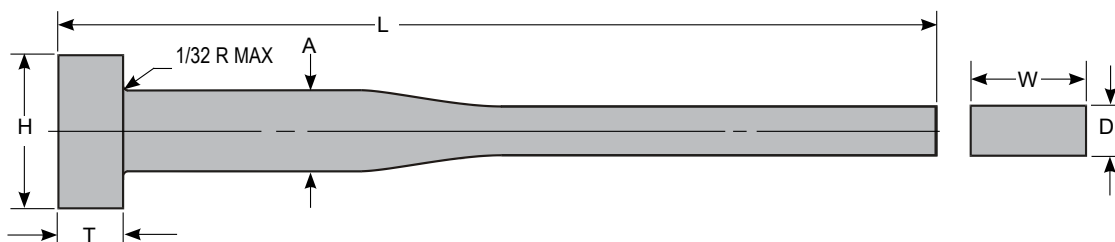

D BLADE THICK. +.0000 / -.0003	BLADE LENGTH	L OVERALL LENGTH +.062 / -.000					
		5"	6"	6-3/8"	7-3/8"	8"	8-3/8"
.024	4-3/8		BE9-2446				
.032	3	BE9-3235	BE9-3236				
.032	4-3/8			BE9-3246	BE9-3247		
.046	3	BE9-4635	BE9-4636				
.046	4-3/8			BE9-4646	BE9-4647		
.024	4-3/8			BE11-2446			
.032	3		BE11-3236			BE11-3238	
.032	4-3/8			BE11-3246	BE11-3247		BE11-3248
.046	3		BE11-4636			BE11-4638	
.046	4-3/8			BE11-4646	BE11-4647		BE11-4648
.024	4-3/8			BE13-2446			
.032	3		BE13-3236			BE13-3238	
.032	4-3/8			BE13-3246	BE13-3247		BE13-3248
.046	3		BE13-4636			BE13-4638	
.046	4-3/8			BE13-4646	BE13-4647		BE13-4648
.062	3		BE13-6236			BE13-6238	
.062	4-3/8			BE13-6246	BE13-6247		BE13-6248

Continued on next page

# Ejector Blades

- One piece construction to improve strength
- Blades are etched for identification
- Corner radius on blade cross-section can be special ordered

SPECIFICATIONS	
Core Hardness	50 - 52 Rc
Surface Hardness	50 - 52 Rc
Material Type	Hot Work Tool Steel
Unit of Measure	Inch



CATALOG NO.	W BLADE WIDTH +.0000 -.0003	A PIN DIA. +.000 -.001	H HEAD DIA. +.000 -.010	T HEAD THICK. +.000 -.002
BE17-	.234	.250	7/16	3/16
BE21-	.296	.312	1/2	1/4
BE25-	.359	.375	5/8	1/4
BE33-	.484	.500	3/4	1/4

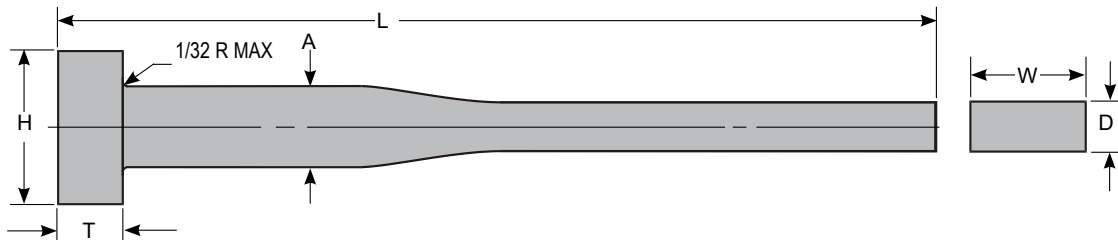

D BLADE THICK. +.0000 -.0003	BLADE LENGTH	L OVERALL LENGTH +.062 / -.000							
		5"	6"	6-3/8"	7-3/8"	8"	8-3/8"	9-3/8"	10-3/8"
.032	3	BE17-3235	BE17-3236			BE17-3238			
.032	4-3/8			BE17-3246	BE17-3247		BE17-3248	BE17-3249	BE17-32410
.046	3	BE17-4635	BE17-4636			BE17-4638			
.046	4-3/8			BE17-4646	BE17-4647		BE17-4648	BE17-4649	BE17-46410
.062	3	BE17-6235	BE17-6236			BE17-6238			
.062	4-3/8			BE17-6246	BE17-6247		BE17-6248	BE17-6249	BE17-62410
.032	4-3/8			BE21-3246	BE21-3247		BE21-3248	BE21-3249	BE21-32410
.046	4-3/8			BE21-4646	BE21-4647		BE21-4648	BE21-4649	BE21-46410
.062	4-3/8			BE21-6246	BE21-6247		BE21-6248	BE21-6249	BE21-62410
.078	4-3/8			BE21-7846	BE21-7847		BE21-7848	BE21-7849	BE21-78410
.032	4-3/8			BE25-3246	BE25-3247		BE25-3248	BE25-3249	BE25-32410
.046	4-3/8			BE25-4646	BE25-4647		BE25-4648	BE25-4649	BE25-46410
.062	4-3/8			BE25-6246	BE25-6247		BE25-6248	BE25-6249	BE25-62410
.078	4-3/8			BE25-7846	BE25-7847		BE25-7848	BE25-7849	BE25-78410
.062	4-3/8			BE33-6256	BE33-6257		BE33-6258	BE33-6259	BE33-62510
.078	4-3/8			BE33-7856	BE33-7857		BE33-7858	BE33-7859	BE33-78510

## Nitrided Ejector Sleeves

- Can be used to eject the part
- Serve as a bushing for the ejector pin
- Etched for easy identification



SPECIFICATIONS	
Bearing Length Tolerance	+ .032 / -.000
I.D. Hardness	68 - 74 Rc Nitrided
O.D. Hardness	68 - 74 Rc Nitrided
Material Type	Hot Work Tool Steel
Unit of Measure	Inch

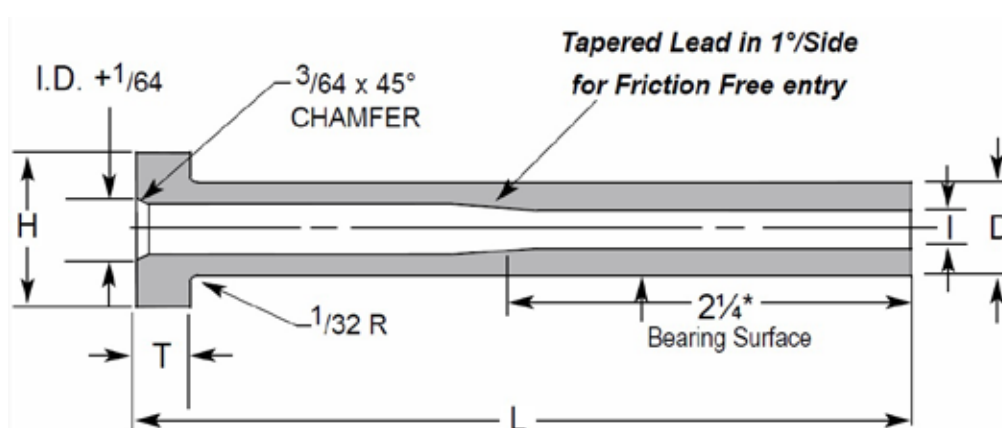

CATALOG NO.	I I.D. +.0005 -0.000	D O.D. +.000 -0.001	H HEAD DIA. +.000 -0.001	T HEAD THICK. +.000 -0.002	L OVERALL LENGTH +.032 / -.000											
					3"	4"	5"	6"	7"	8"	9"	10"	11"	12"	13"	14"
SL13-*	3/32	3/16	3/8	3/16	•	•	•	•	•							
SL15-*	1/8	7/32	13/32	3/16	•	•	•	•	•	•						
SL17-	5/32	1/4	7/16	3/16		•	•	•	•	•	•	•	•	•	•	•
SL21-	3/16	5/16	1/2	1/4		•	•	•	•	•	•	•	•	•	•	•
SL23-	7/32	11/32	9/16	1/4		•	•	•	•	•	•	•	•	•	•	•
SL25-	1/4	3/8	5/8	1/4		•	•	•	•	•	•	•	•	•	•	•
SL29-	5/16	7/16	11/16	1/4		•	•	•	•	•	•	•	•	•	•	•
SL33-	3/8	1/2	3/4	1/4		•	•	•	•	•	•	•	•	•	•	•
SL37-	7/16	5/8	7/8	1/4		•	•	•	•	•	•	•	•	•	•	•
SL39-	1/2	11/16	15/16	1/4		•	•	•	•	•	•	•	•	•	•	•
SL41-	9/16	3/4	1	1/4		•	•	•	•	•	•	•	•	•	•	•
SL45-	5/8	7/8	1-1/8	1/4		•	•	•	•	•	•	•	•	•	•	•
SL47-	3/4	1	1-1/4	1/4		•	•	•	•	•	•	•	•	•	•	•

\*SL13 & SL15 Bearing Length is 1-3/4"

Add length to catalog number (i.e. SL13-3)

## Oversized Ejector Sleeves

- Can be used to eject the part
- Serve as a bushing for the ejector pin
- Etched for easy identification
- O.D. is .005 oversized

SPECIFICATIONS	
I.D. Hardness	65 - 74 Rc
O.D. Hardness	65 - 74 Rc
Material Type	Hot Work Tool Steel
Unit of Measure	Inch

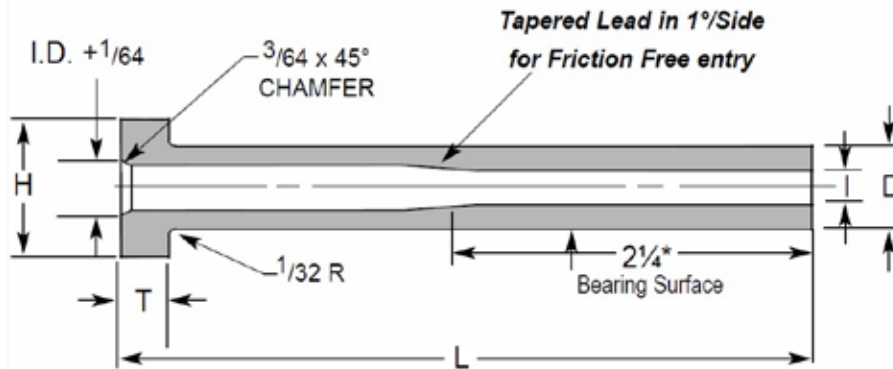

CATALOG NO.	I I.D. +.0005 -.0000	D O.D. +.000 -.001	H HEAD DIA. +.000 -.001	T HEAD THICK. +.000 -.002	L OVERALL LENGTH +.032 / -.000							
					4"	5"	6"	7"	8"	9"	10"	
OSL13-*	3/32	3/16	3/8	3/16	•	•	•	•	•	•	•	•
OSL15-*	1/8	7/32	13/32	3/16	•	•	•					
OSL17-	5/32	1/4	7/16	3/16	•	•	•	•	•	•	•	•
OSL21-	3/16	5/16	1/2	1/4	•	•	•	•	•	•	•	•
OSL25-	1/4	3/8	5/8	1/4	•	•	•	•	•	•	•	•
OSL29-	5/16	7/16	11/16	1/4	•	•	•	•	•	•	•	•
OSL33-	3/8	1/2	3/4	1/4	•	•	•	•	•	•	•	•

\*OSL13 & OSL15 Bearing Length is 1-3/4"  
Add length to catalog number (i.e. OSL13-4)

## Nitrided Ejector Sleeves - D-Head

CATALOG NO.	I I.D. +.0005 -.0000	D O.D. +.000 -.001	H HEAD DIA. +.000 -.001	T HEAD THICK. +.000 -.002	L OVERALL LENGTH +.032 / -.000									
					6"	7"	8"	9"	10"	11"	12"	13"	14"	
DSL15-	1/8	7/32	13/32	3/16			•							
DSL17-	5/32	1/4	7/16	3/16	•				•	•	•	•	•	
DSL21-	3/16	5/16	1/2	1/4			•							
DSL23-	7/32	11/32	9/16	1/4							•			
DSL25-	1/4	3/8	5/8	1/4								•		
DSL29-	5/16	7/16	11/16	1/4				•						

Add length to catalog number (i.e. DSL15-6)

## Thin Wall Ejector Sleeves

- Eliminate the need to machine a step in standard sleeves
- Can be used as alternative to standard sleeves in applications where the wall foot print is too large
- Nickel coating provides added durability & increased corrosion protection
- Electroless Nickel Coated .00003" - .00007" thick



SPECIFICATIONS	
Material Type	A2 Tool Steel
Core Hardness	58 - 60 Rc
Unit of Measure	Inch

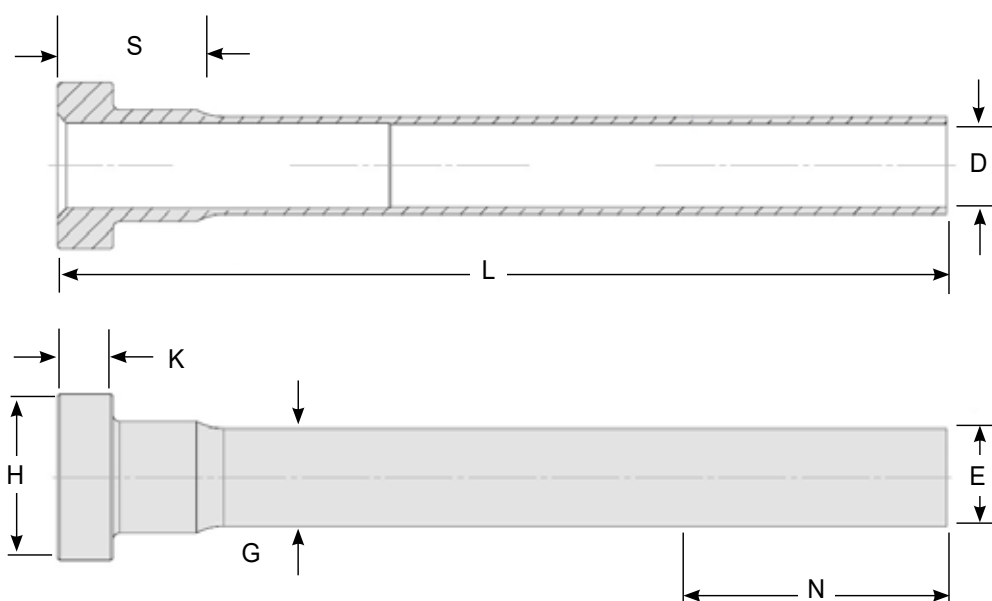

NOMINAL SLEEVE I.D.	D I.D. +.0003 -.0000	E O.D. -.0003 -.0007	G SHOULDER DIAMETER +.000 -.001	H HEAD DIA. +.000 -.010	K HEAD THICK. +.000 -.002	N BEARING LENGTH	S SHOULDER LENGTH +.010 -.010	L OVERALL LENGTH +.032 / -.000	
								4"	6"
3/32	.0937	.1563	.188	.37	.187	1.75	.500	TWS13-4	TWS13-6
1/8	.1250	.1875	.219	.40	.187	1.75	.500	TWS15-4	TWS15-6
5/32	.1562	.2187	.250	.43	.187	2.50	.500	TWS17-4	TWS17-6
3/16	.1875	.2500	.312	.50	.250	2.50	.625	TWS21-4	TWS21-6
7/32	.2187	.2813	.344	.56	.250	2.50	.625	TWS23-4	TWS23-6
1/4	.2500	.3125	.375	.62	.250	2.50	.625	TWS25-4	TWS25-6
5/16	.3125	.3750	.438	.68	.250	2.50	.625	TWS29-4	TWS29-6
3/8	.3750	.4375	.500	.75	.250	2.50	.625	TWS33-4	TWS33-6



## Ejector Sleeve Extensions

- Lengthens sleeves quickly and inexpensively
- Four lengths available for more versatility
- Special lengths available upon request

SPECIFICATIONS	
Extension Head Thickness	.250
Pin Head Cavity Length	.500
Material Type	12L14
Unit of Measure	Inch

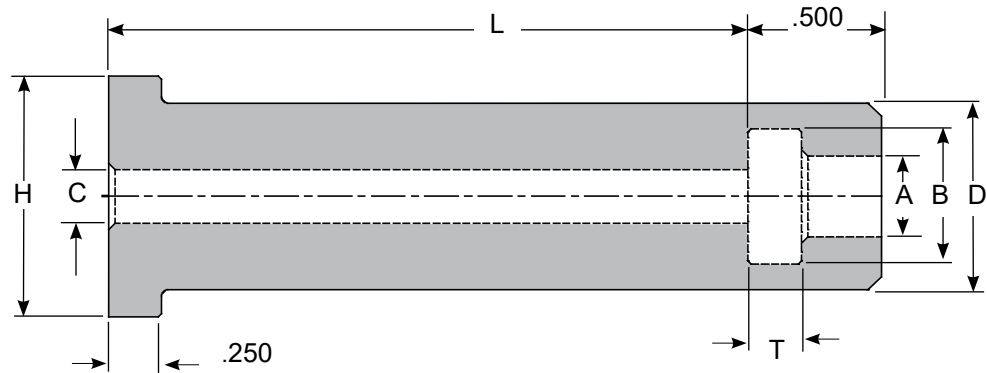
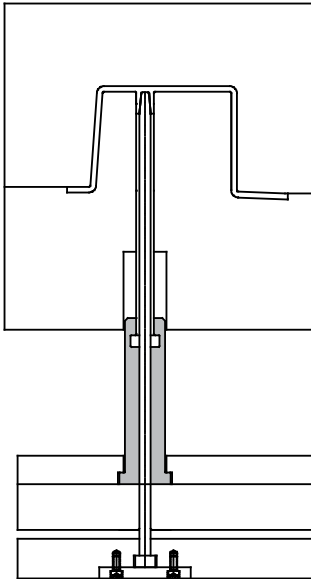

NOMINAL SLEEVE I.D.	D O.D. +.000 -.002	A +.002 -.000	B +.005 -.000	T +.002 -.0000	C I.D. +.03 -.00	H +.000 -.010	OVERALL LENGTH			
							2.50"	3.00"	3.50"	4.00"
							L SHOULDER LENGTH			
							2.00"	2.50"	3.00"	3.50"
3/32	.625	.193	.385	.188	.17	.875	SLX13-20	SLX13-25	SLX13-30	
1/8	.625	.224	.416	.188	.17	.875	SLX15-20	SLX15-25	SLX15-30	
5/32	.625	.255	.448	.188	.17	.875	SLX17-20	SLX17-25	SLX17-30	SLX17-35
3/16	.875	.318	.510	.251	.22	1.125	SLX21-20	SLX21-25	SLX21-30	SLX21-35
7/32	.875	.349	.570	.251	.25	1.125	SLX23-20	SLX23-25	SLX23-30	SLX23-35
1/4	.875	.380	.630	.251	.28	1.125	SLX25-20	SLX25-25	SLX25-30	SLX25-35
5/16	1.000	.443	.698	.251	.34	1.250	SLX29-20	SLX29-25	SLX29-30	SLX29-35
3/8	1.000	.505	.760	.251	.41	1.250	SLX33-20	SLX33-25	SLX33-30	SLX33-35

**Page Left Blank Intentionally**

**Page Left Blank Intentionally**



Turn To The Industry Experts

**Page Left Blank Intentionally**

## Hex Series Knockout Rod Extensions

- Increases ejection stroke for knockout rod
- Black oxide coating helps to inhibit corrosion

SPECIFICATIONS	
Hex Size	7/8
Material Type	4140
Surface Hardness	28 - 32 Rc
Unit of Measure	Inch

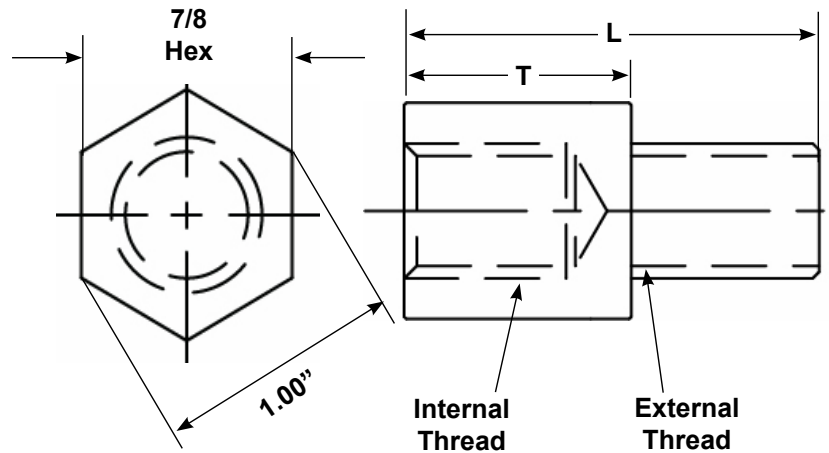
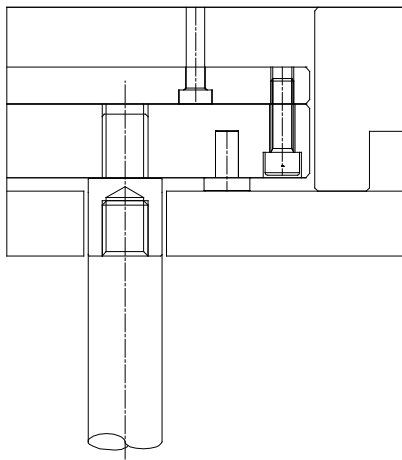

CATALOG NO.	L OVERALL LENGTH	T SHOULDER LENGTH	THREAD SIZE
KRE37-10	1.672	1.052	3/8-16
KRE50-10	1.672	1.052	1/2-13
KRE50-15	2.175	1.552	1/2-13
KRE62-10	1.922	1.052	5/8-11
KRE62-15	2.422	1.552	5/8-11
KRE75-10	1.672	1.052	3/4-10
KRE75-15	2.422	1.552	3/4-10
KRE75-10NT	1.922	1.052	No Female Thread
KRE75-15NT	2.422	1.552	No Female Thread

## Round Series Knockout Rod Extensions

- Increases ejection stroke for knockout rod
- Black oxide coating helps to inhibit corrosion
- 1/4 -20 SCHS included



SPECIFICATIONS	
Material Type	4140
Surface Hardness	28 - 32 Rc
Unit of Measure	Inch

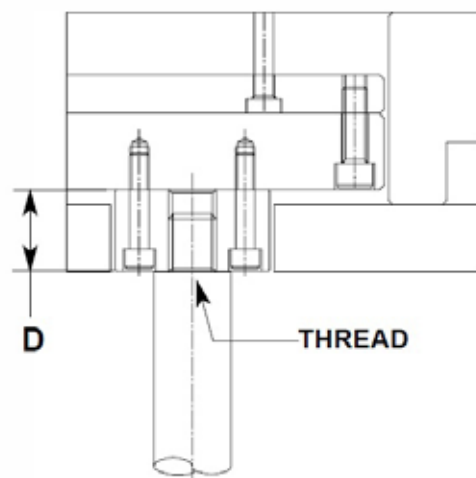
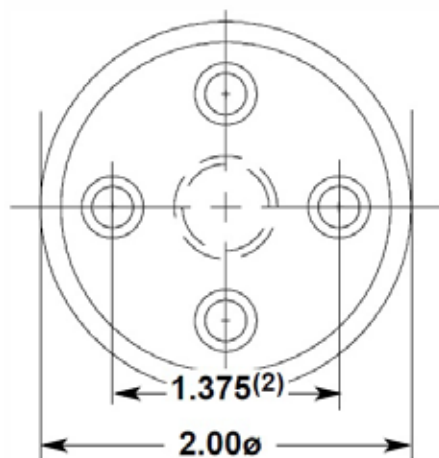

CATALOG NO.	D OVERALL HEIGHT	THREAD SIZE
KR37-10	1.052	3/8-16
KR37-15	1.552	3/8-16
KR50-10	1.052	1/2-13
KR50-15	1.552	1/2-13
KR62-10	1.052	5/8-11
KR62-15	1.552	5/8-11
KR75-10	1.052	3/4-10
KR75-15	1.552	3/4-10
KR75-10NT	1.052	No Female Thread
KR75-15NT	1.552	No Female Thread